



**katalog náhradních dílů**  
**automatického kotle**

**VERNER**  
**A602**  
**A492**

VERNER SK s.r.o  
Klincová 37/b  
821 08 Bratislava  
SLOVENSKÁ REPUBLIKA  
e-mail: kotle-verner@email.cz

PONAST spol. s r.o  
Na Potůčkách 163  
757 01 Valašské Meziříčí  
ČESKÁ REPUBLIKA  
e-mail: ponast@ponast.cz



aktualizace: 11/12/2024





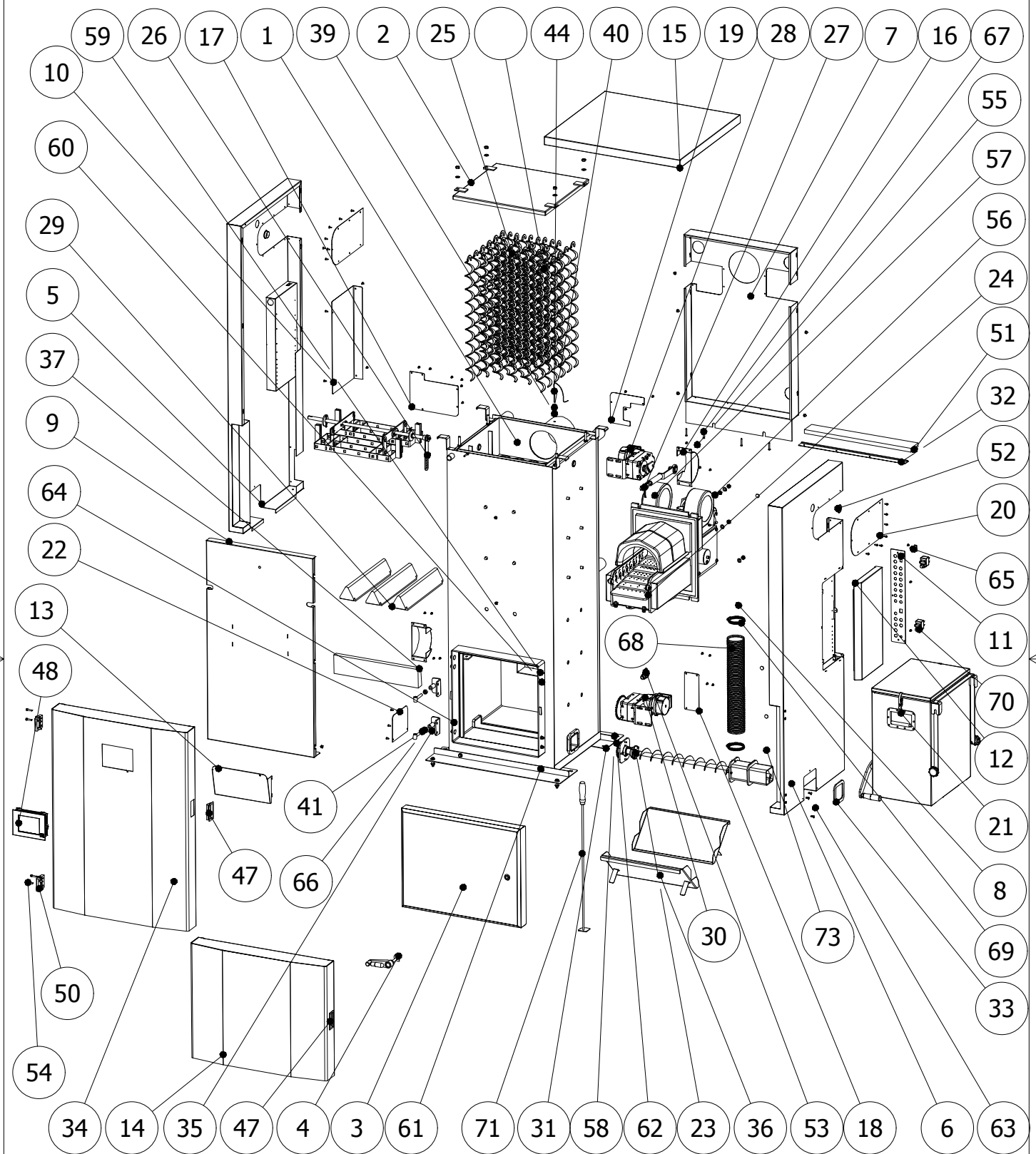

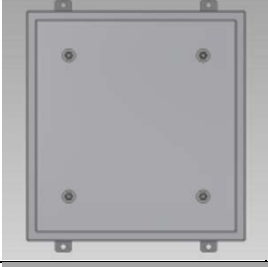
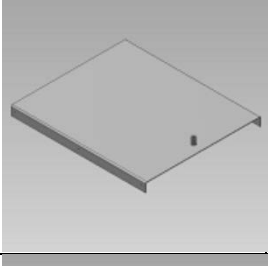

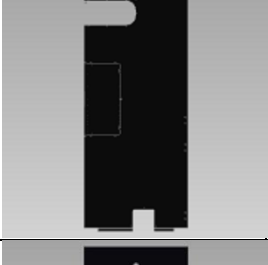
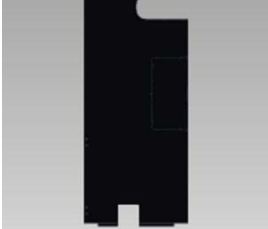

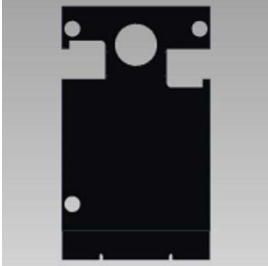
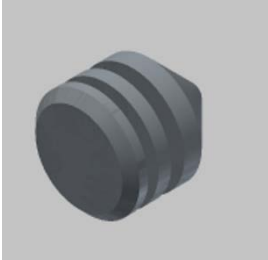
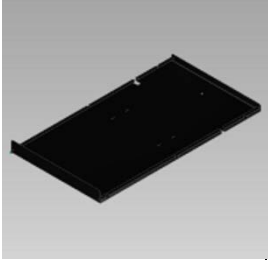
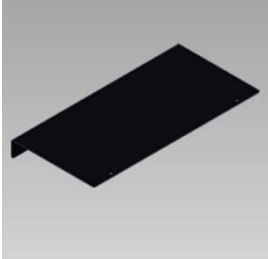
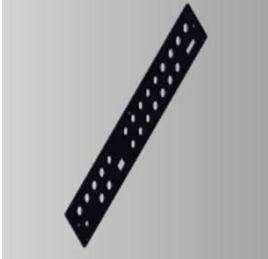
# KOTEL A602, A492



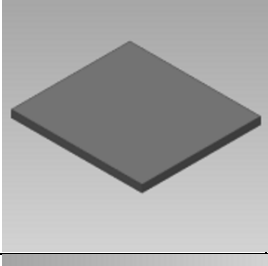
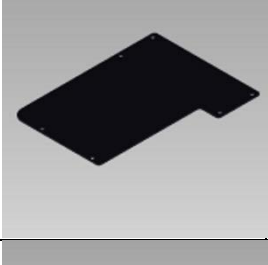
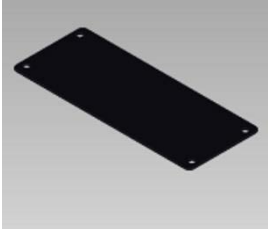

KOTEL A602	POZICE	POPIS	KÓD	ČÍSLO SOUČÁSTI	POČET KS	POZNÁMKY
	1	TĚLESO KOTLOVÉ	PKXX6201	338.S01.000.A1	1	Sestava
	2	VÍKO	KKTX0011	005.S02.000.A2	1	Sestava
	3	DVÍŘKA	KKTX0034	338.S05.000.A3	1	Sestava
	4	KLIKA x2	KKTX0019	338.S04.000.A3	1	Sestava
	5	BOČNICE LEVÁ	PKMD0155	723.S01.000.A3	1	
	6	BOČNICE PRAVÁ	PKMD0157	723.S02.000.A3	1	

KOTEL A602	POZICE	POPIS	KÓD	ČÍSLO SOUČÁSTI	POČET KS	POZNÁMKY
	7	KRYT ZADNÍ	PKMD0112	338.010.000.A2	1	
	8	KLÍČ	PKRX0008	286.000.000.A4	14	
	9	VZPĚRA 1	PKMD0166	723.006.000.A4	1	
	10	KRYT KRABICE	PKMD0168	723.008.000.A3	1	
	11	DESKA	PKMD0143	723.005.000.A4	1	
	12	KRYT JEDNOTKY BOČNÍ	PKMD0142	726.008.000.A3	1	

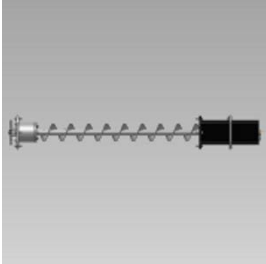
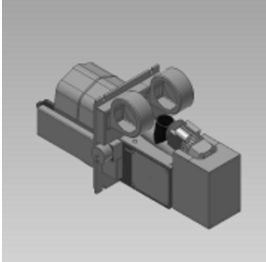
KOTEL A602	POZICE	POPIS	KÓD	ČÍSLO SOUČÁSTI	POČET KS	POZNÁMKY
	13	ŠUPLÍK	PKMD0169	723.010.000.A3	1	
	14	KRYT DVEŘÍ KP62	PKMC0162	723.S04.000.A3	1	
	15	VÍKO HORNÍ- SVAŘENEC	PKMC0164	723.S05.000.A4	1	
	16	KRYT ČISTĚNÍ	PKMD0081	397.S13.000.A3	2	
	17	KRYTKA OTVORU MOTORU	PKMD0104	338.S06.002.A4	1	
	18	ZÁSLEPKA MOTORU	PKMD0099	338.S07.002.A4	1	

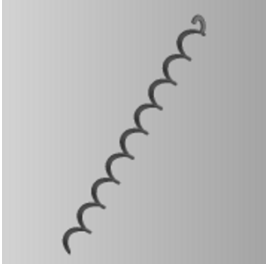
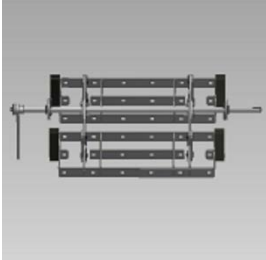

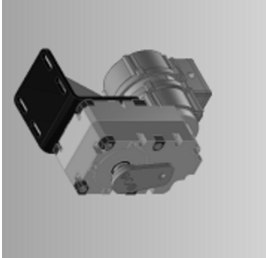
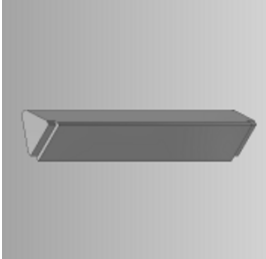
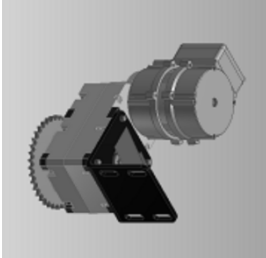
KOTEL A602	POZICE	POPIS	KÓD	ČÍSLO SOUČÁSTI	POČET KS	POZNÁMKY
	19	KRYTKA ZAD	PKMD0102	338.S07.007.A4	1	
	20	KRYTKA POHONU ČISTĚNÍ	PKMD0071	397.S07.006.A3	2	
	21	POPELNICE 80L	KKTL0041 KKTL0039	448.000.000.A3	1	Sestava PRAVÁ LEVÁ
	22	KRYTKA POHONU VYMETÁNÍ 1	PKMD0105	338.S06.005.A3	1	
	23	VYMETÁNÍ POPELE	KKTX0035	334.000.000.A2	1	Sestava
	24	HOŘÁK S POSUVNÝM ROŠTEM 60KW	KVHXX6000	875.000.000.A2	1	Sestava

KOTEL A602	POZICE	POPIS	KÓD	ČÍSLO SOUČÁSTI	POČET KS	POZNÁMKY
	25	TURBULÁTOR PLOCHÝ 645mm	MRUZ0178	713.000.000.A4	36	
	26	ČISTĚNÍ VÝMĚNÍKU	KKTX0064	797.000.000.A3	1	Sestava
	27	MECHANISMU S ČISTĚNÍ	KKTX0024	424.000.000.A3	1	Sestava
	28	POHON ČISTĚNÍ TAHŮ	KKTX0041	727.S25.000.A3	1	Sestava
	29	KERAMIKA TROJÚHELNÍKOVÁ	MTKE0135	420.900.000.A3	3	
	30	POHON VYMETÁNÍ	KKTX0042	723.S24.000.A3	1	Sestava



KOTEL A602	POZICE	POPIS	KÓD	ČÍSLO SOUČÁSTI	POČET KS	POZNÁMKY
	31	DRŽÁK KOTLE	PKRX0046	356.000.000.A3	2	
	32	DRŽÁK SIBRALU	PKMD0120	338.056.000.A4	1	
	33	TĚSNĚNÍ	PKTX0157	334.S08.005.A4	1	
	34	ČELO A602	PKMC0221	885.S03.000.A3	1	
	35	PANT DÍL 2	PKTX0238	338.S01.S43.A3	2	
	36	LOPATKA	PKTX0174	334.009.000.A3	2	

KOTEL A602	POZICE	POPIS	KÓD	ČÍSLO SOUČÁSTI	POČET KS	POZNÁMKY
	37	KERAMIKA NAD DVÍŘKA	MTKE0001	338.053.000.A4	1	
	39	REDUKCE DÍL 1	PKRX0062	792.001.000.A4	1	
	40	REDUKCE DÍL 2	PKRX0063	792.002.000.A4	1	
	41	PANT DVÍŘEK	PKTX0037	005.S05.S03.A4	2	
	42	KRYT DVÍŘEK	PKMD0116	338.012.000.A2	1	

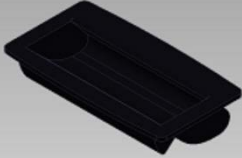
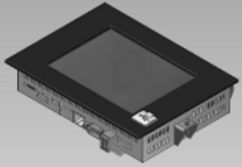
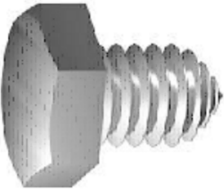
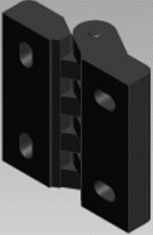
KOTEL A602	POZICE	POPIS	KÓD	ČÍSLO SOUČÁSTI	POČET KS	POZNÁMKY
	44	Snímač teploty TR 050J-x TCK, 1,4m	METR0108		1	
	46	Šroub vratový - M8 x 20	MSSX0024	ISO 8678	8	
	47	Rukojeť EPR_90_Pf_C 1	MRUZ0205		2	
	48	TERMINÁL DOTYKOVÝ HZS 555-S	METR0150		1	
	49	Šroub do plechu - ST4,2 x 13	MSSX0012		2	
	50	Pant ELESA CFA.65-SL-H-V	PKTX0295		4	

KOTEL A602	POZICE	POPIS	KÓD	ČÍSLO SOUČÁSTI	POČET KS	POZNÁMKY
	51	SIBREX 300 20x80x594	MTIZ0018		1	
	52	ZÁSLEPKA ČERNÁ 35- 38mm	MRUZ0228		2	
	53	VENTIL VYPOŠTĚCÍ S PÁČKOU	MRUZ0024		1	
	54	Šroub s válcovou hlavou - M6 x 16	MSSX0224	DIN 912 - M6 x 16	16	
	55	Šrouby samořezné - ST 4,8 x 13	MSSX0118	ISO 7049	39	
	56	Vějířová pojistná podložka - A 10,5	MSPX0003	DIN 6798	2	

KOTEL A602	POZICE	POPIS	KÓD	ČÍSLO SOUČÁSTI	POČET KS	POZNÁMKY
	57	Šestihránná matice - M10	MSMX0002	DIN 934	6	
	58	Podložka - A 10,5	MSPX0005	DIN 125	16	
	59	Podložka - A 8,4	MSPX0001	DIN 125	24	
	60	Šestihránná matice - M8	MSMX0016	DIN 934	30	
	61	Šestihránný šroub - M8 x 20	MSSX0002	DIN 933	4	
	62	Šestihránný šroub - M8 x 40	MSSX0027	DIN 933	4	

KOTEL A602	POZICE	POPIS	KÓD	ČÍSLO SOUČÁSTI	POČET KS	POZNÁMKY
	63	Nýt zarážecí pr.5mm 27024050	MSSX0125		4	
	65	Vypínač SSk 315 RED	MERX0579		1	
	66	Šestihranné matice - M12	MSMX0007		2	
	67	Šroub do plechu - ST4,8 x 38	MSSX0042		4	
	68	HADICE FLEXADUR PU- 1NO DN 80x1000	MRUZ0018		1	
	69	SPONA HADICOVÁ 70- 90 NEREZ	MRUZ0089		2	

KOTEL A602	POZICE	POPIS	KÓD	ČÍSLO SOUČÁSTI	POČET KS	POZNÁMKY
	70	HAVARIJNÍ TERMOSTAT	METR0049 METR0277		1 1	hořák kotl. těleso
	71	ŠKRABKA	PKRX0001	001.S32.000.A4	1	
	72	MAGNET 18x2	MRUZ0077		4	

# TĚLESO KOTLOVÉ

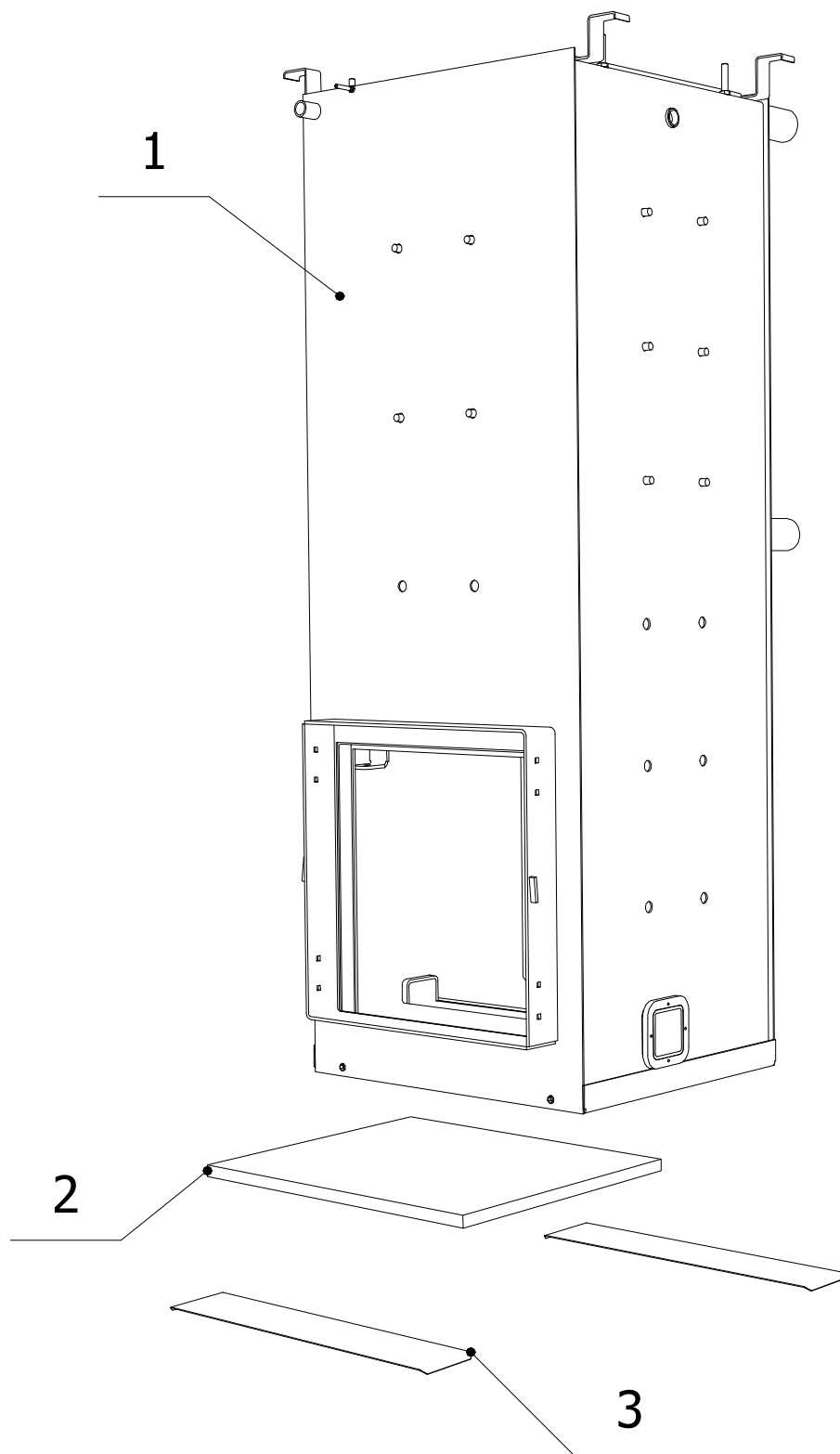



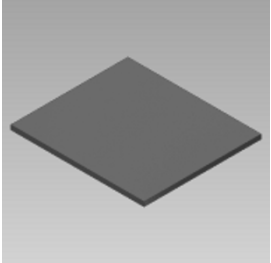
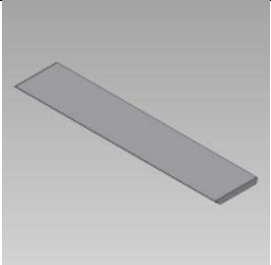

TĚLESO KOTLOVÉ KP62	POZICE	POPIS	KÓD	ČÍSLO SOUČÁSTI	POČET KS	POZNÁMKY
	1	TĚLESO KOTLOVÉ	PKXX6201	338.S01.000.A1	1	
	2	IZOLACE 20x515x586	PKTX0344		1	
	3	DRŽÁK IZOLACE	KKTX0348		2	

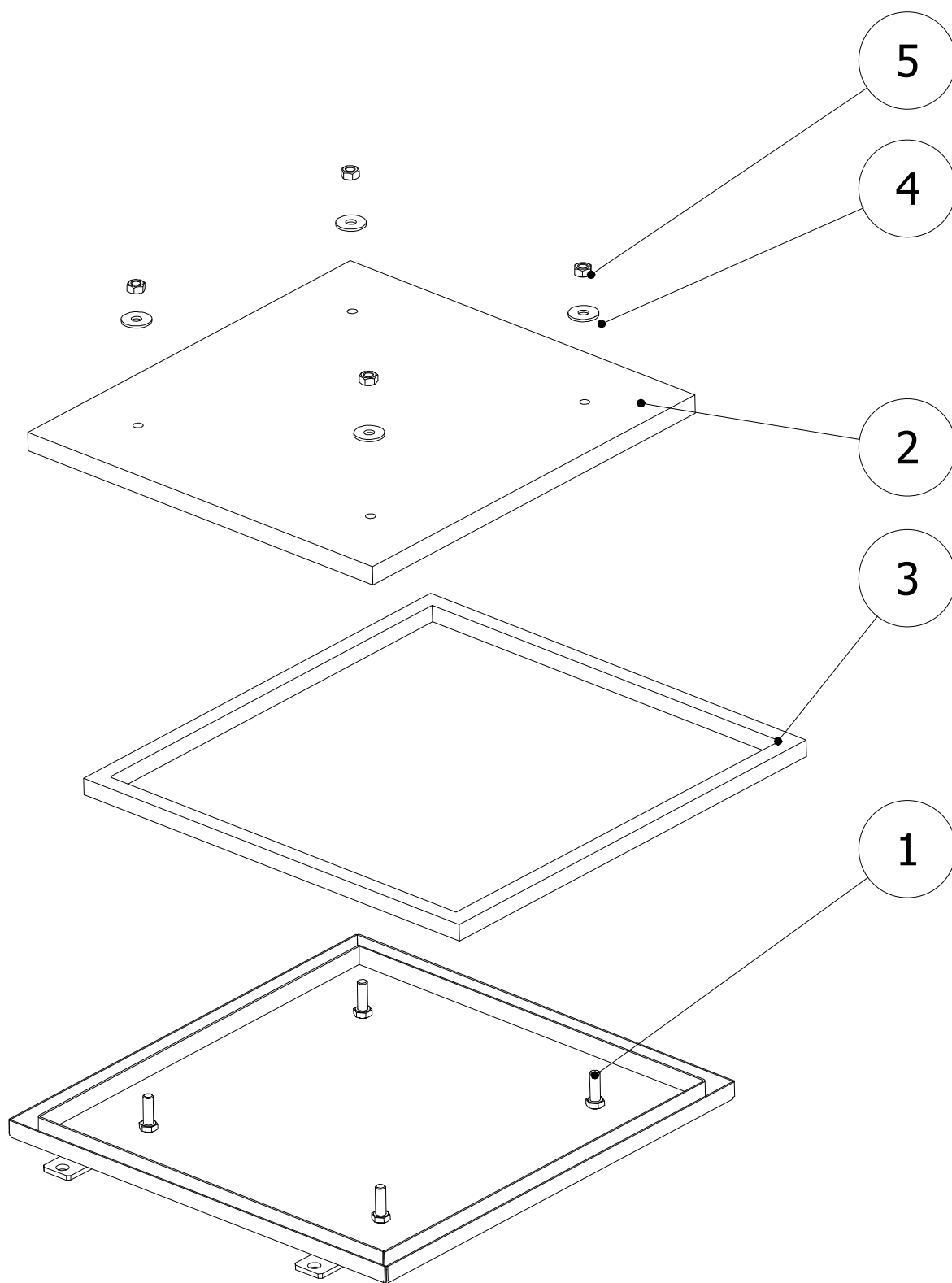
VÍKO

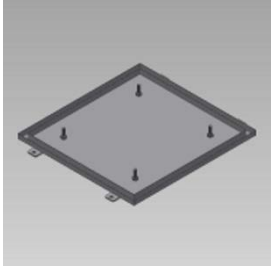
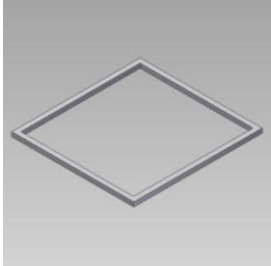

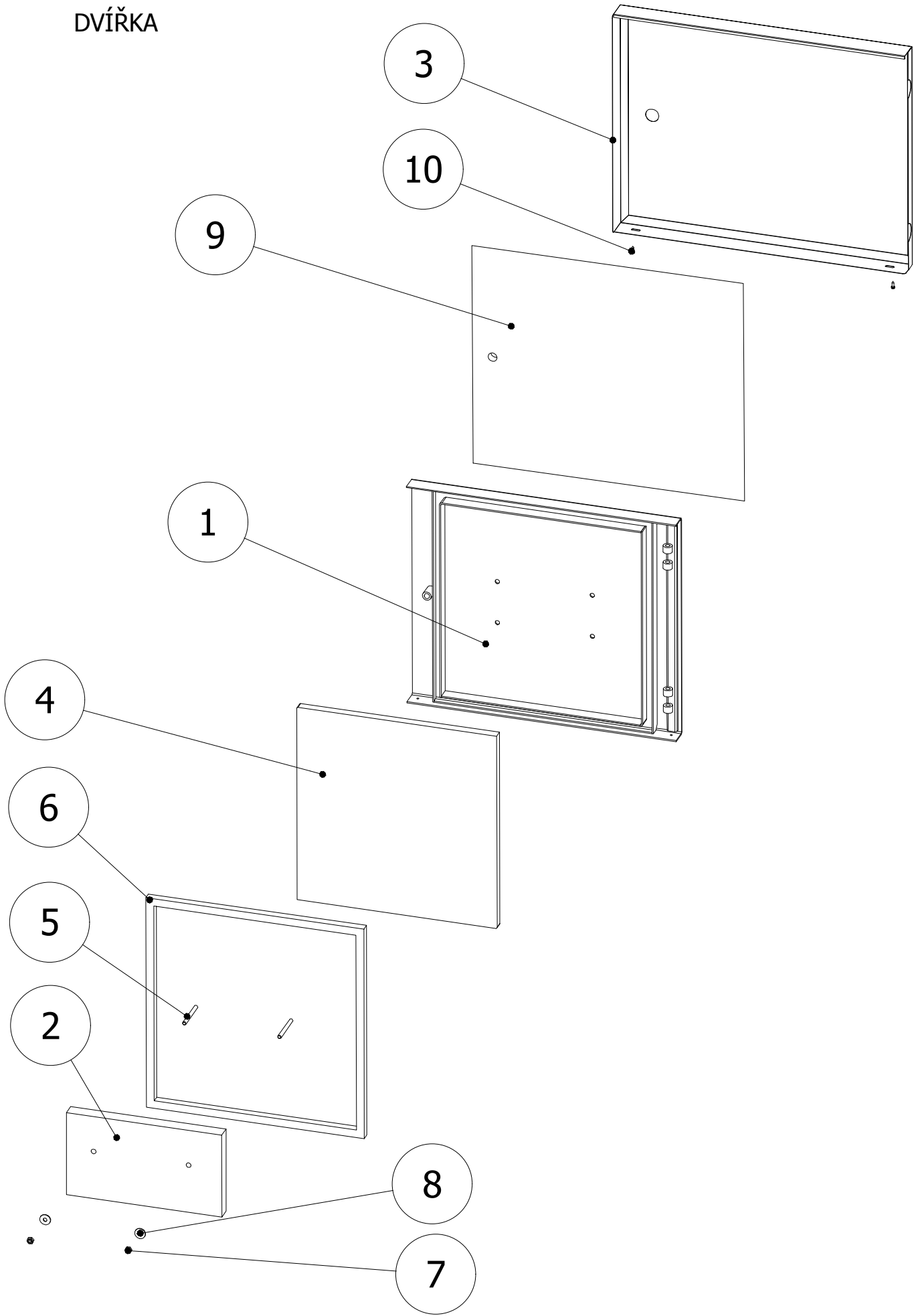

VÍKO	POZICE	POPIS	KÓD	ČÍSLO SOUČÁSTI	POČET KS	POZNÁMKY
	1	VÍKO KOTL.TĚLESA	PKTX0100	005.002.000.A2	1	
	2	SIBREX 140 20x446x475	MTIZ0001		1	
	3	ŠŇŮRA VÍKA 18x18	MRUZ0133		1.52m	
	4	Podložka - 10,5	MSPX0004	DIN 9021	4	
	5	Šestihranné matice - M10	MSMX0002	ISO 4032	4	

DVÍŘKA

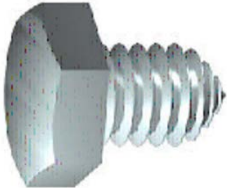

DVÍŘKA	POZICE	POPIS	KÓD	ČÍSLO SOUČÁSTI	POZICE KS	POZNÁMKY
	1	DVÍŘKA	PKTX0243	338.005.000.A3	1	
	2	KERAMIKA NA DVÍŘKA	MTKE0010	338.017.000.A4	1	
	3	KRYT DVÍŘEK	PKMD0116	338.012.000.A2	1	
	4	SIBREX 300 20x457.5x4 67	MTIZ0008		1	
	5	TYČ ZÁVITOVÁ M8x85	PKTX0268		2	
	6	ŠŇŮRA TĚSN. 18x18	MRUZ0133		2.01m	

DVÍŘKA	POZICE	POPIS	KÓD	ČÍSLO SOUČÁSTI	POZICE KS	POZNÁMKY
	7	Šestihránná matice - M8	MSMX0016	DIN 934	2	Zn
	8	Podložka - 8,4	MSPX0008	DIN 9021	2	
	9	IZOLACE DVÍŘEK KP62 20x530x620	MTIZ0011		1	
	10	Šroub do plechu - ST4,2 x 13	MSSX0012	ISO 1479	2	

KLIKA

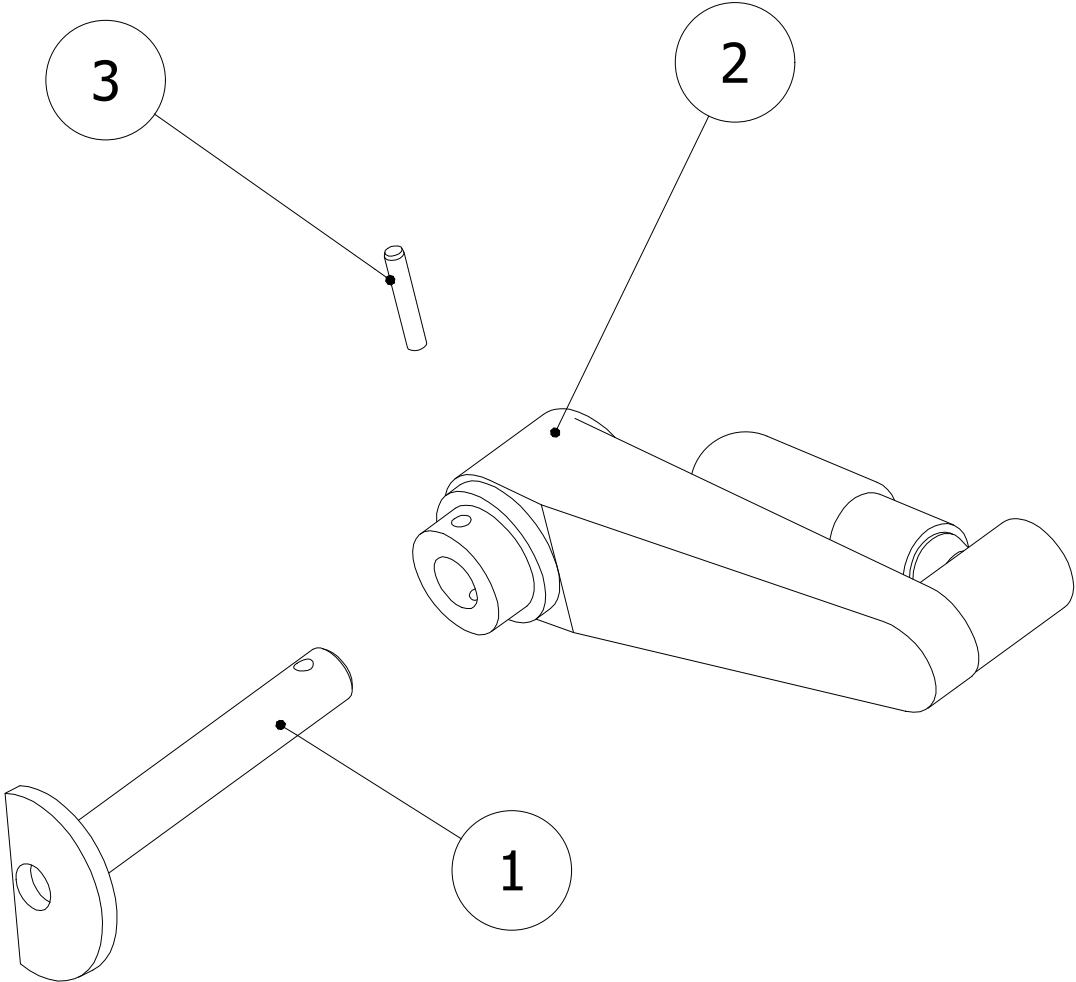

KLIIKA	POZICE	POPIS	KÓD	ČÍSLO SOUČÁSTI	POČET KS	POZNÁMKY
	1	DŘÍK KLIKY	PKTX0118	054.S04.001.A3	1	
	2	KLIIKA SKLAPOVACÍ ELESA GANTER	MRUZ0117	MT.100-AT+IR	1	KÓD 44317
	3	Kolík - 4 x 24 - A (kalený)	MSRX0003	ISO 8734	1	





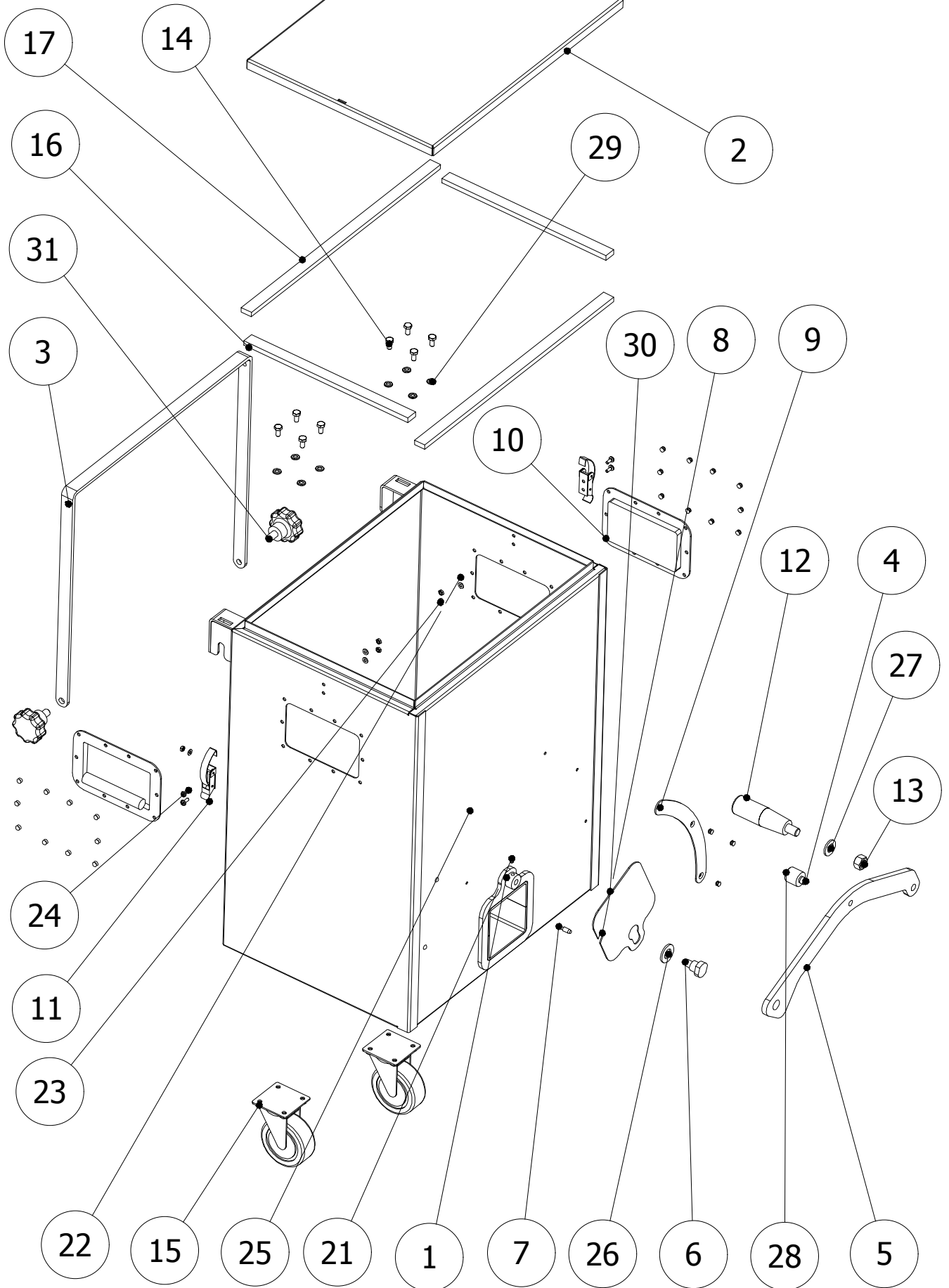

POPELNICE 80L



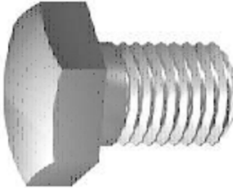

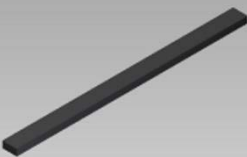
Popelnice 80L	POZICE	POPIS	KÓD	ČÍSLO SOUČÁSTI	POČET KS	POZNÁMKY
	1	POPELNICE	PKTD0251	448.S01.000.A3	1	
	2	DEKL POPELNICE 80L	PKTC0256	448.S03.000.A4	1	
	3	DRŽADLO	PKTD0199	448.011.000.A4	1	
	4	DRŽÁK MAGNETICKÝ	PKTX0198	448.009.000.A4	1	
	5	PÁKA	PKTD0196	448.005.000.A3	1	
	6	ŠROUB	PKTX0197	448.006.000.A4	1	

Popelnice 80L	POZICE	POPIS	KÓD	ČÍSLO SOUČÁSTI	POČET KS	POZNÁMKY
	7	DISTANCE	PKMX0037	054.009.003.A4	1	
	8	ZÁKLOPKA	MHVT0186	448.012.000.A4	1	
	9	DRÁHA	PKTX0201	448.028.000.A4	1	
	10	Ocelová sklápěcí rukojeť 147x110 mm	MRUZ0055		2	
	11	UZÁVĚR UP3	MRUZ0010		2	
	12	DLOUHÁ KUŽ. RUKOJEŤ	MRUZ0062	OBJ.Č.460650	1	

Popelnice 80L	POZICE	POPIS	KÓD	ČÍSLO SOUČÁSTI	POČET KS	POZNÁMKY
	13	Šestihránné matice - M12	MSMX0007	ISO 4032	1	
	14	Šrouby se šestihránnou hlavou - M6 x 12	MSSX0083	ISO 4017	8	
	15	Šestihránné matice - M6	MSMX0001	ISO 4032	8	
	16	TĚSNĚNÍ SILIKONOVÉ 8x18-290	MRUZ0066		2	
	17	TĚSNĚNÍ SILIKONOVÉ 8x18-443	MRUZ0122		2	
	20	KOLO PEVNÉ EGA 075/FLP PR.75	MRUZ0056	FA.MONTAKO	2	

Popelnice 80L	POZICE	POPIS	KÓD	ČÍSLO SOUČÁSTI	POČET KS	POZNÁMKY
	21	Stavěcí šrouby - M5 x 10	MSRX0015	ISO 4027	1	
	22	Ploché podložky - 4	MSPX0014	ISO 7089	5	
	23	Šestihranné matice - M4	MSSX0012	ISO 4032	5	
	24	Šrouby s válc. hl. s kří. drážk. - M4 x 10	MSSX0010	ISO 7045	4	
	25	Nýt - B 4 x 8	MSRX0064	DIN 660	3	
	26	Podložka - A 16	MSPX0022	DIN 125	1	

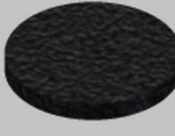
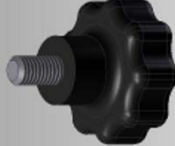
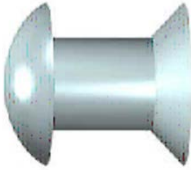
Popelnice 80L	POZICE	POPIS	KÓD	ČÍSLO SOUČÁSTI	POČET KS	POZNÁMKY
	27	Ploché podložky - 12	MSPX0020	ISO 7089	1	
	28	MAGNET 18x3	MRUZ0088		1	
	29	Ploché podložky - 6	MSPX0026	ISO 7090	8	
	30	MAGNET 18x2	MRUZ0077		1	
	31	ŠROUB KOVOVÝ S PLAST.HLAV OU M10x17	MRUZ0032	OBJ.Č.105a-068-D/MxL	2	
	32	NÝT TRHACÍ 4x8 AL/ST	MSRX0013		23	

# VYMETÁNÍ POPELE

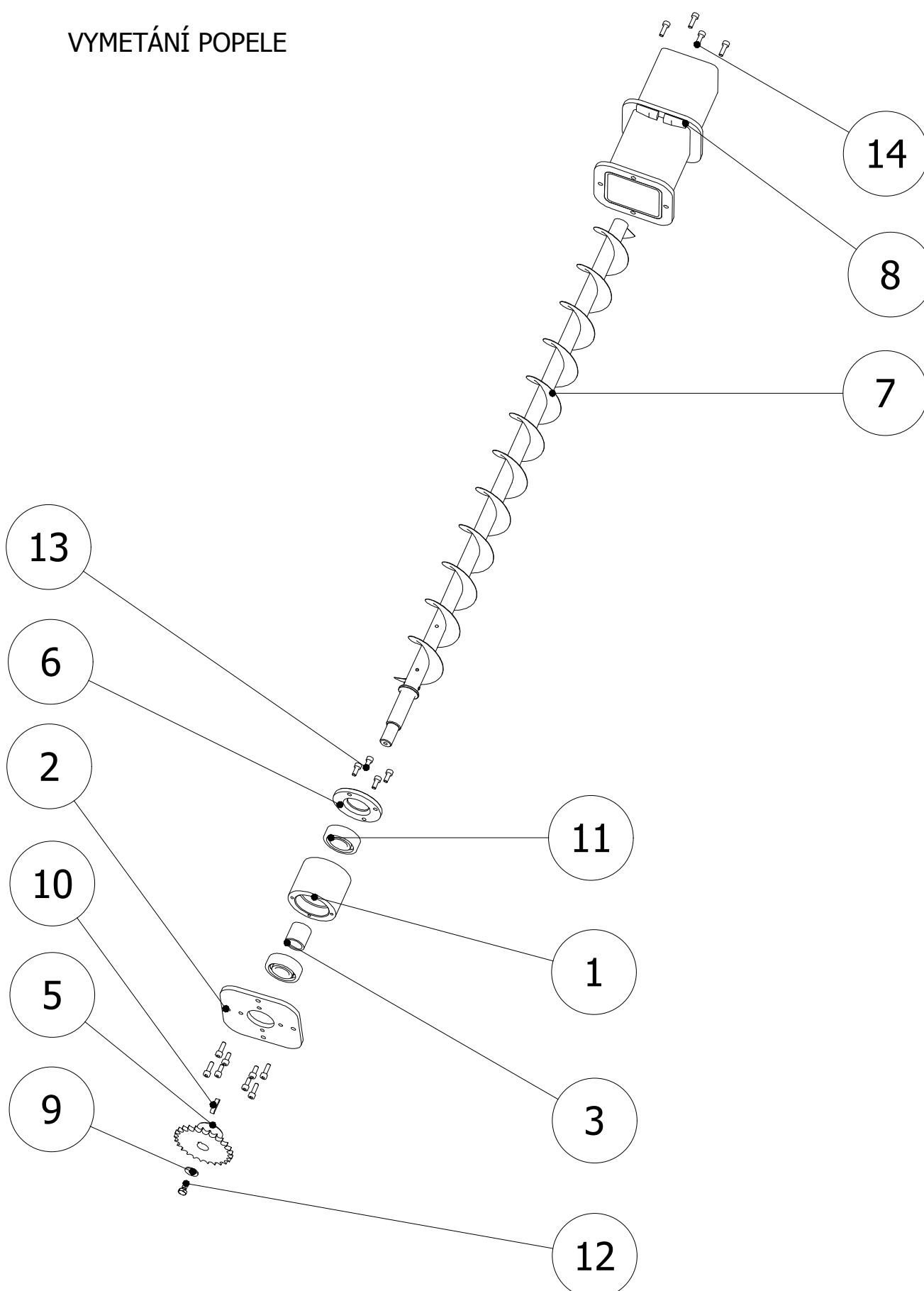

VYMETÁNÍ POPELE	POZICE	POPIS	KÓD	ČÍSLO SOUČÁSTI	POČET KS	POZNÁMKY
	1	NÁBOJ	PKTX0140	334.001.000.A 4	1	
	2	VÍKO 1	PKTX0150	334.002.000.A 4	1	
	3	DISTANCE	PKTX0440	334.003.000.A 4	1	
	5	KOLO ŘETĚZOVÉ S NÁB.3/8"x7/32 "	PKTX0143	334.005.000.A 4	1	
	6	VÍKO 2	PKTX0144	334.006.000.A 4	1	
	7	ŠNEK	PKTX0146	334.S07.000.A 3	1	

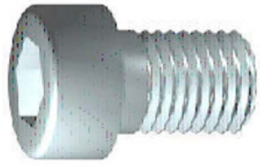

VYMETÁNÍ POPELE	POZICE	POPIS	KÓD	ČÍSLO SOUČÁSTI	POČET KS	POZNÁMKY
	8	VEDENÍ ŠNEKU	PKTX0153	334.S08.000.A 3	1	
	9	Podložka - 6,4	MSPX0002	DIN 9021	1	
	10	Těsné pero - A 5 x 5 x 22	MSRX0006	DIN 6885	1	
	11	Kuličková ložiska jednořadá - 6204	MRUZ0246	CSN 02 4630	2	
	12	Šestihranný šroub - M6 x 10	MSSX0019	DIN 933	1	Zn
	13	Šroub s válnovou hlavou - M5 x 12	MSSX0137	DIN 912	8	

VYMETÁNÍ POPELE	POZICE	POPIS	KÓD	ČÍSLO SOUČÁSTI	POČET KS	POZNÁMKY
	14	Šroub s válcovou hlavou - M5 x 16	MSSX0055	DIN 912	8	

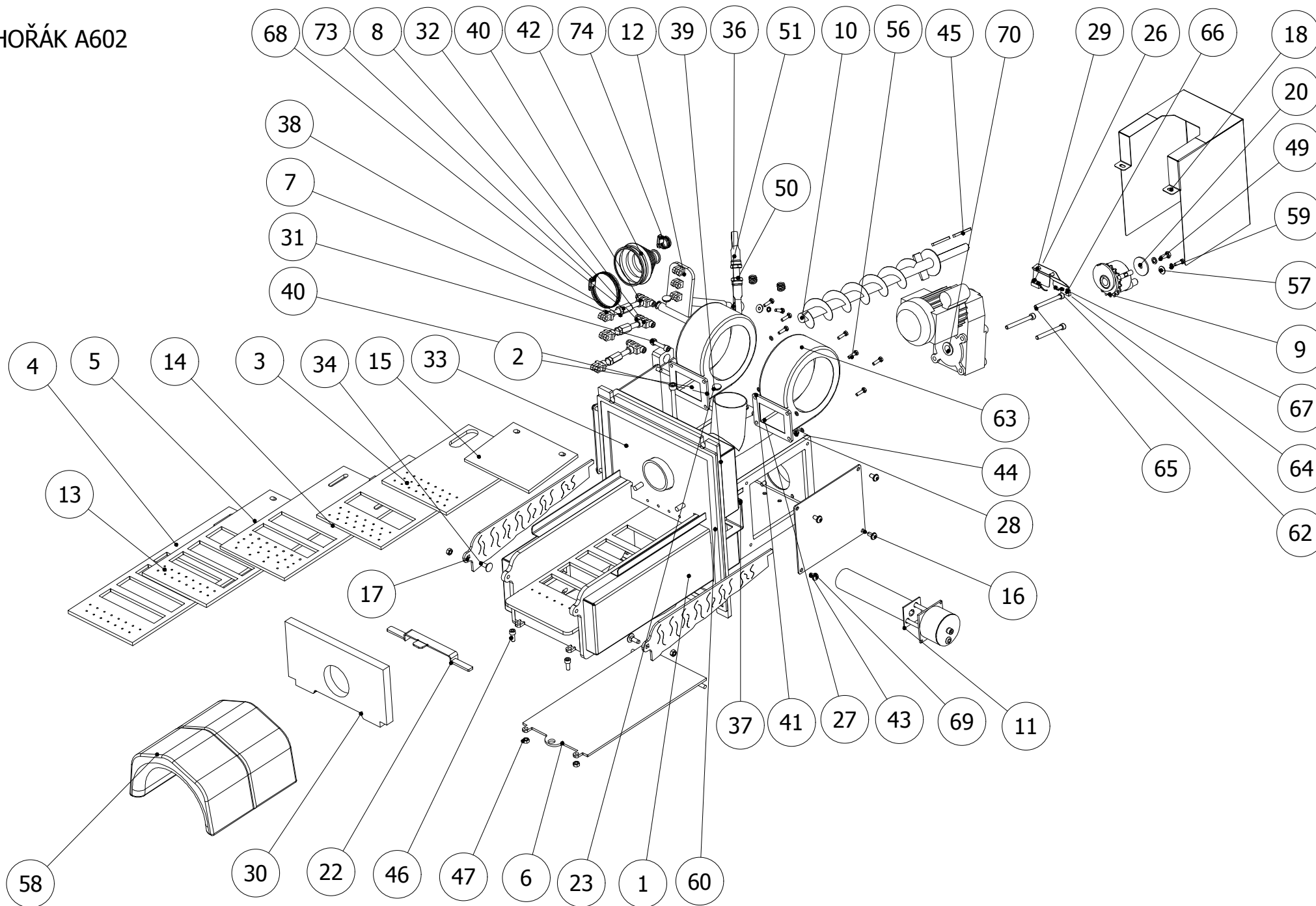

# HOŘÁK A602

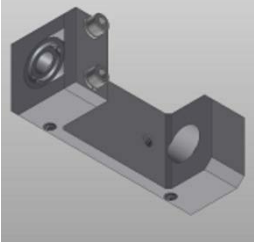
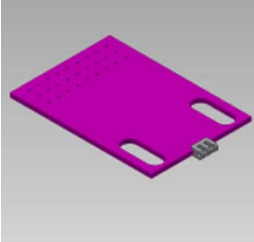

Hořák A602	POZICE	POPIS	KÓD	ČÍSLO SOUČÁSTI	POČET KS	POZNÁMKY
	1	TĚLESO HOŘÁKU 60KW	PVHXX6000	875.S01.000.A1	1	
	2	DOMEČEK ROŠTOVÁNÍ	PVHXX0149	875.A02.000.A4	1	Sestava
	3	ROŠTNICE 1	PVHXX0033	875.S03.000.A3	1	
	4	ROŠTNICE 2	PVHXX0036	875.S04.000.A3	1	
	5	ROŠTNICE 3	PVHXX0038	875.S05.000.A3	1	
	6	KRYT SPODNÍ	PVHXX0040	875.S06.000.A3	1	

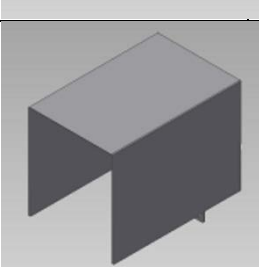
Hořák A602	POZICE	POPIS	KÓD	ČÍSLO SOUČÁSTI	POČET KS	POZNÁMKY
	7	UNAŠEČ 1	PVHXX0043	875.S07.000.A4	3	
	8	UNAŠEČ 2	PVHXX0045	875.S08.000.A4	3	
	9	PŘEVODOVKA ND set	PVHXX0145	875.S09.000.A4	1	Sestava
	10	ŠNEK HOŘÁKU	PVHXX0057	875.S10.000.A3	1	
	11	SYSTÉM ZAPALOVÁNÍ A302,A602	PVHXX0059	875.S11.000.A3	1	Sestava
	12	PÁKA ROŠTOVACÍ	PVHXX0135	875.S02.000.A3	1	

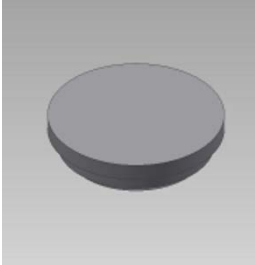
Hořák A602	POZICE	POPIS	KÓD	ČÍSLO SOUČÁSTI	POČET KS	POZNÁMKY
	13	DESKA STÍRACÍ 3	PVHXX0064	875.013.000.A4	1	
	14	DESKA STÍRACÍ 2	PVHXX0065	875.014.000.A4	1	
	15	DESKA STÍRACÍ 1	MVHVH0066	875.015.000.A4	1	
	16	VÍKO	PVHXX0067	875.016.000.A4	2	
	17	DESKA CHRÁNIČE	PVWHX0068	875.S14.001.A4	2	
	18	KRYT POHONU	PVHXX0083	875.018.000.A3	1	

Hořák A602	POZICE	POPIS	KÓD	ČÍSLO SOUČÁSTI	POČET KS	POZNÁMKY
	20	PODLOŽKA	MVHVH0070	875.020.000.A4	1	
	22	ROZRAŽEČ	PVHXX0150	875.B22.000.A4	1	PVHXX0144 původní
	23	ZÁTKA	PVHXX0134	886.023.000.A4	2	
	26	DRŽÁK SNÍMAČE	PVHXX0074	875.030.000.A4	1	
	27	Podložka - A 5,3	MSPX0036	DIN 125	8	Zn
	28	Podložka - A 6,4	MSPX0026	DIN 125	2	Zn

Hořák A602	POZICE	POPIS	KÓD	ČÍSLO SOUČÁSTI	POČET KS	POZNÁMKY
	29	Šrouby s půlkul. hl. s vnitř. šestihr - M6 x 12	MSSX0141	ISO 7380	2	Zn
	30	DESKA 20x168x303	MTIZ0087	875.060.000.A4	1	
	31	Samojistná šestihranná matice - M8	MSSX0003	ISO 7040	6	Zn
	32	Šroub s válcovou hlavou - M8 x 45	MSSX0221	DIN 912	6	Zn
	33	Šroub s válcovou hlavou - M8 x 16	MSSX0179	DIN 7984	4	
	34	Šroub s půlkl.hl. a čtverh. krčkem - M8 x 25	MSSX0239	DIN 603	2	NEREZ









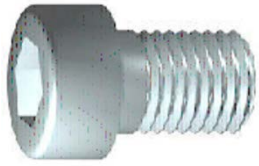

Hořák A602	POZICE	POPIS	KÓD	ČÍSLO SOUČÁSTI	POČET KS	POZNÁMKY
	36	OKO KLOUBOVÉ GN 648.1-14- M14-W	MRUZ0445		2	Zn
	37	Šroub IMB. - M5 x 10	MSSX0030	CSN 02 1143	2	Zn
	38	Šestihránná matice - M10	MSSX0002	DIN 934	3	Zn
	39	Šroub IMB. - M10 x 110	MSSX0219	CSN 02 1143	2	Zn
	40	Pružná podložka - A8	MSPX0006	DIN 128	15	Zn
	41	Ventilátor RG12S-2EP	PKRX0132		2	

Hořák A602	POZICE	POPIS	KÓD	ČÍSLO SOUČÁSTI	POČET KS	POZNÁMKY
	42	Manžeta poloosy ke kolu UNI 5786	MRUZ0446		1	
	43	Šrouby s půlkul. hl. s vnitř. šestihř. - M8 x 16	MSSX0135	ISO 7380	8	Zn
	44	Šrouby s půlkul. hl. s vnitř. šestihř. - M6 x 16	MSSX0098	ISO 7380	2	Zn
	45	Těsné pero - A 5 x 5 x 56	MSRX0128	DIN 6885	2	ČERNÁ
	46	Šroub s válcovou hlavou - M8 x 20	MSSX0071	DIN 912	2	Zn
	47	Šestihranné matice - M8	MSMX0016	ISO 4032	2	Zn

Hořák A602	POZICE	POPIS	KÓD	ČÍSLO SOUČÁSTI	POČET KS	POZNÁMKY
	49	Šestihřanný šroub - M8 x 20	MSSX0002	DIN 933	1	ČERNÁ
	50	Šestihřanná matice - M14	MSMX0044	DIN 439	2	
	51	TYČ ZÁVITOVÁ M14-75 Zn	PVHXX0076		1	Zn
	56	Šestihřanný šroub - M6 x 16	MSSX0142	DIN 933	10	Zn
	57	Podložka - 6,4	MSPX0011	DIN 9021	2	Zn
	58	REFLEKTOR KERAMICKÝ V 60KW	MTKE0120	875.050.000.A3	2	Zn

Hořák A602	POZICE	POPIS	KÓD	ČÍSLO SOUČÁSTI	POČET KS	POZNÁMKY
	59	Zubová pojistná podložka - A 6,4	MSPX0012	DIN 6797	4	Zn
	60	TĚSNĚNÍ SAMOLEPÍCÍ 2x20	MRUZ0302		3m	
	62	Snímač MEDER MK04-1A66-dl. 1900mm	MERX0777		2	
	63	Pojistné hřídelové kroužky - 9	MSRX0136	CSN 02 2929	2	
	64	Šroub se zápustnou hlavou - M3 x 16	MSSX0114	ISO 7045	4	Zn

Hořák A602	POZICE	POPIS	KÓD	ČÍSLO SOUČÁSTI	POČET KS	POZNÁMKY
	65	Šroub s válcovou hlavou - M8 x 80	MSSX0045	DIN 912	4	Zn
	66	Šestihranná matice - M3	MSMX0008	DIN 934	4	Zn
	67	Zubová pojistná podložka - A 3,2	MSPX0029	DIN 6797	4	Zn
	68	Matice M10x13x25 spojovací	MSMX0013		3	Zn
	69	Podložka - A 8,4	MSPX0001	DIN 125	8	Zn
	70	Motor FT105 U88,9/40W	MEMPO040		1	Zn

Hořák A602	POZICE	POPIS	KÓD	ČÍSLO SOUČÁSTI	POČET KS	POZNÁMKY
	73	SPONA HADICOVÁ 70- 90 NEREZ	MRUZ0089		2	
	74	SPONA HADICOVÁ 16- 25 NEREZ	MRUZ0250		1	

DOMEČEK ROŠTOVÁNÍ A302, A602

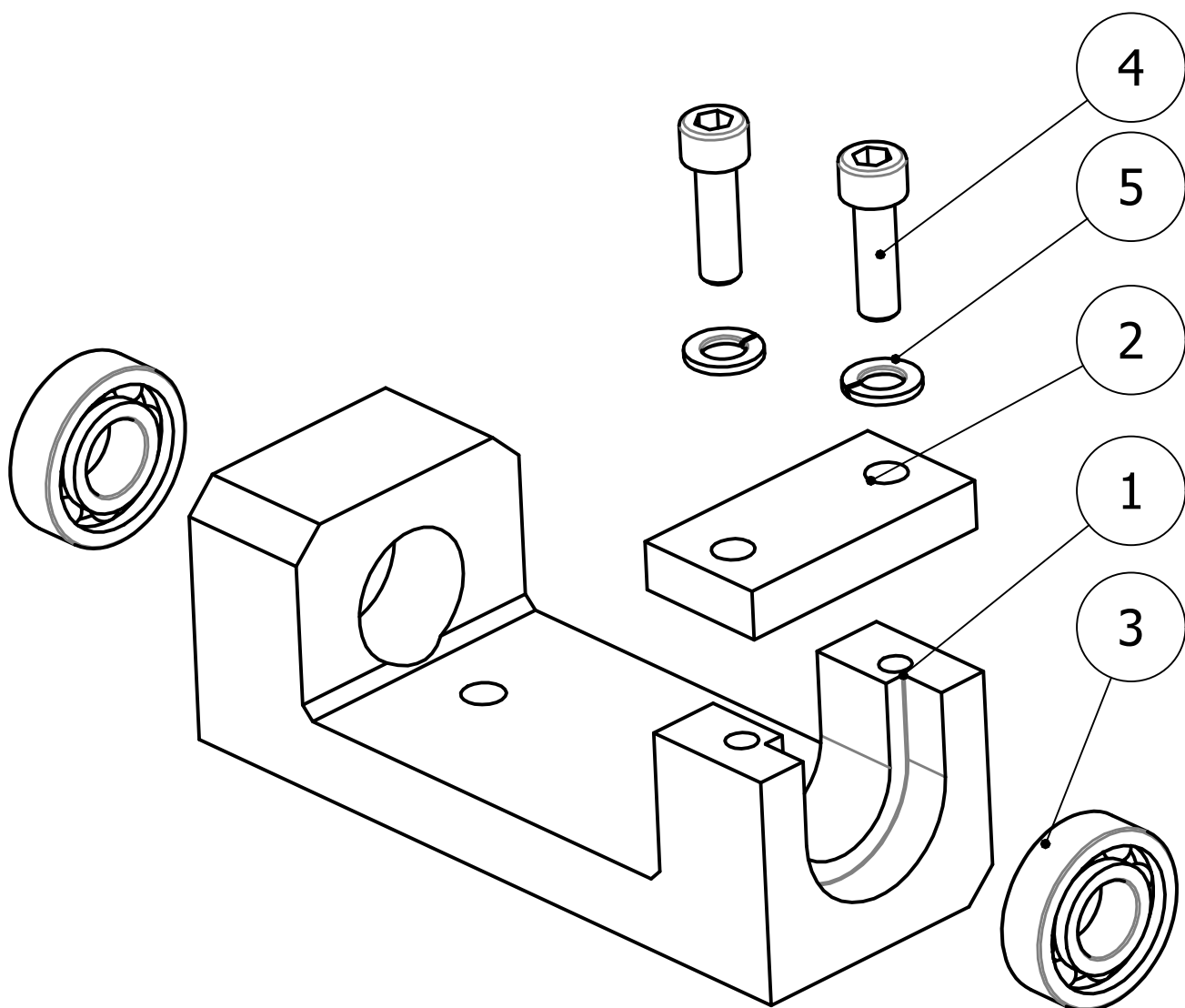

Domeček	POZICE	POPIS	KÓD	ČÍSLO SOUČÁSTI	POČET KS	POZNÁMKY
	1	DOMEČEK	MRUZ0489	875.A02.001.A 3	1	
	2	1/2 DOMEČEK U	MVHVH0137	875.A02.002.A 4	1	
	3	Kuličková ložiska jednořadá - 6001	MRUZ0485	CSN 02 4630	2	
	4	Šroub imbus - M6 x 20	MSSX0182	ISO 4762	2	
	5	Pružná podložka - A6	MSPX0019	DIN 128	2	



# ROZPAD PŘEVODOVKY

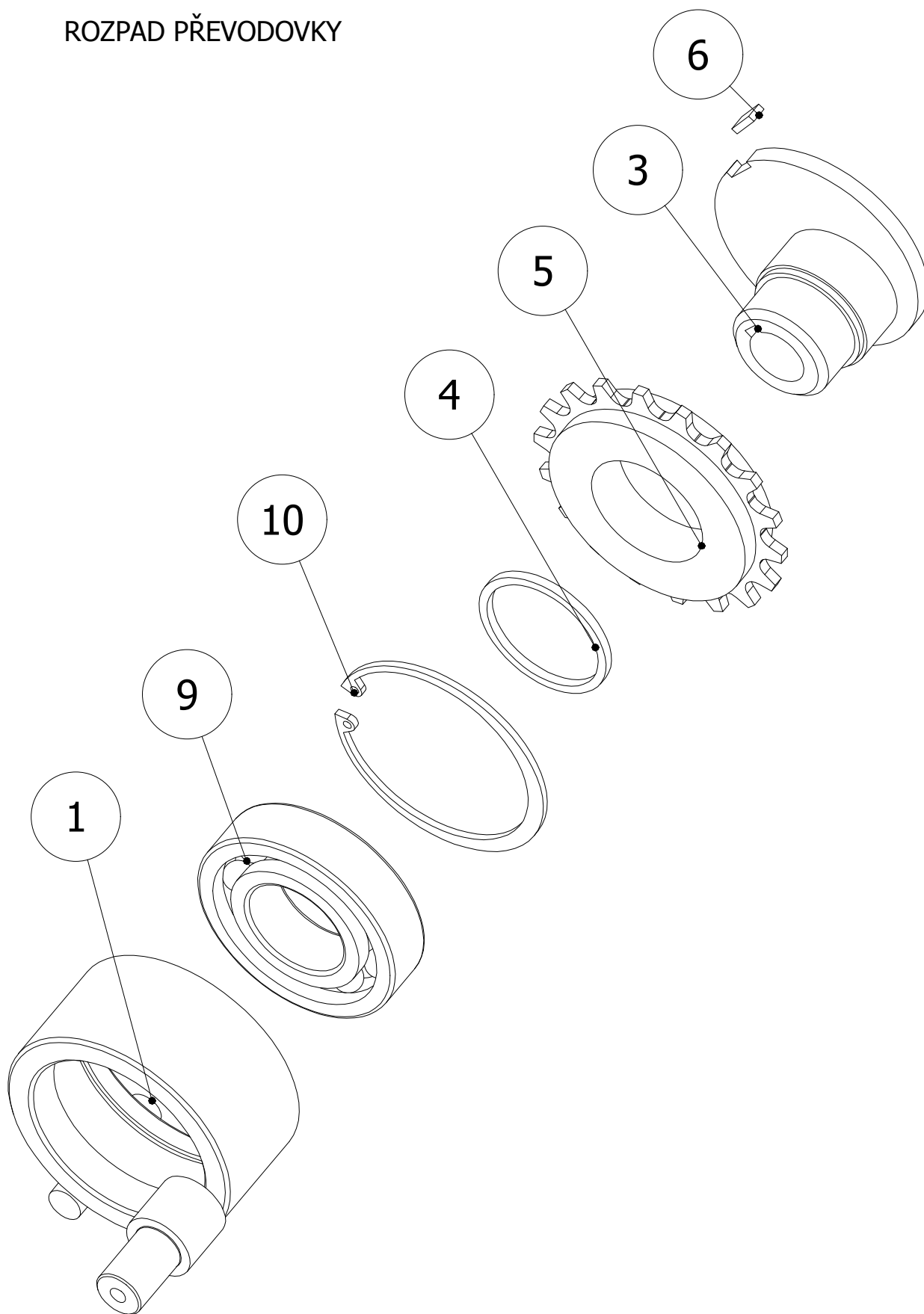



Převodovka	POZICE	POPIS	KÓD	ČÍSLO SOUČÁSTI	POČET KS	POZNÁMKY
	1	SKŘÍŇ PŘEVODOVKY	PVHXX0047	875.S09.S01.A4	1	
	3	NÁBOJ S VAČKOU	PVHXX0054	875.S09.S03.A4	1	
	4	DISTANCE	PVHXX0077	875.S09.004.A4	1	
	5	Kolo ozubené 18 zubů m50.0740	MRUZ0362		1	
	6	Magnet neodym.10x5x2 Au	MRUZ0484		2	
	9	Kuličková ložiska jednořadá - 6206 2RS	MRUZ0439	CSN 02 4630	1	

Převodovka	POZICE	POPIS	KÓD	ČÍSLO SOUČÁSTI	POČET KS	POZNÁMKY
	10	Pojistné kroužky pro otvory - 62	MSRX0113	CSN 022931	1	

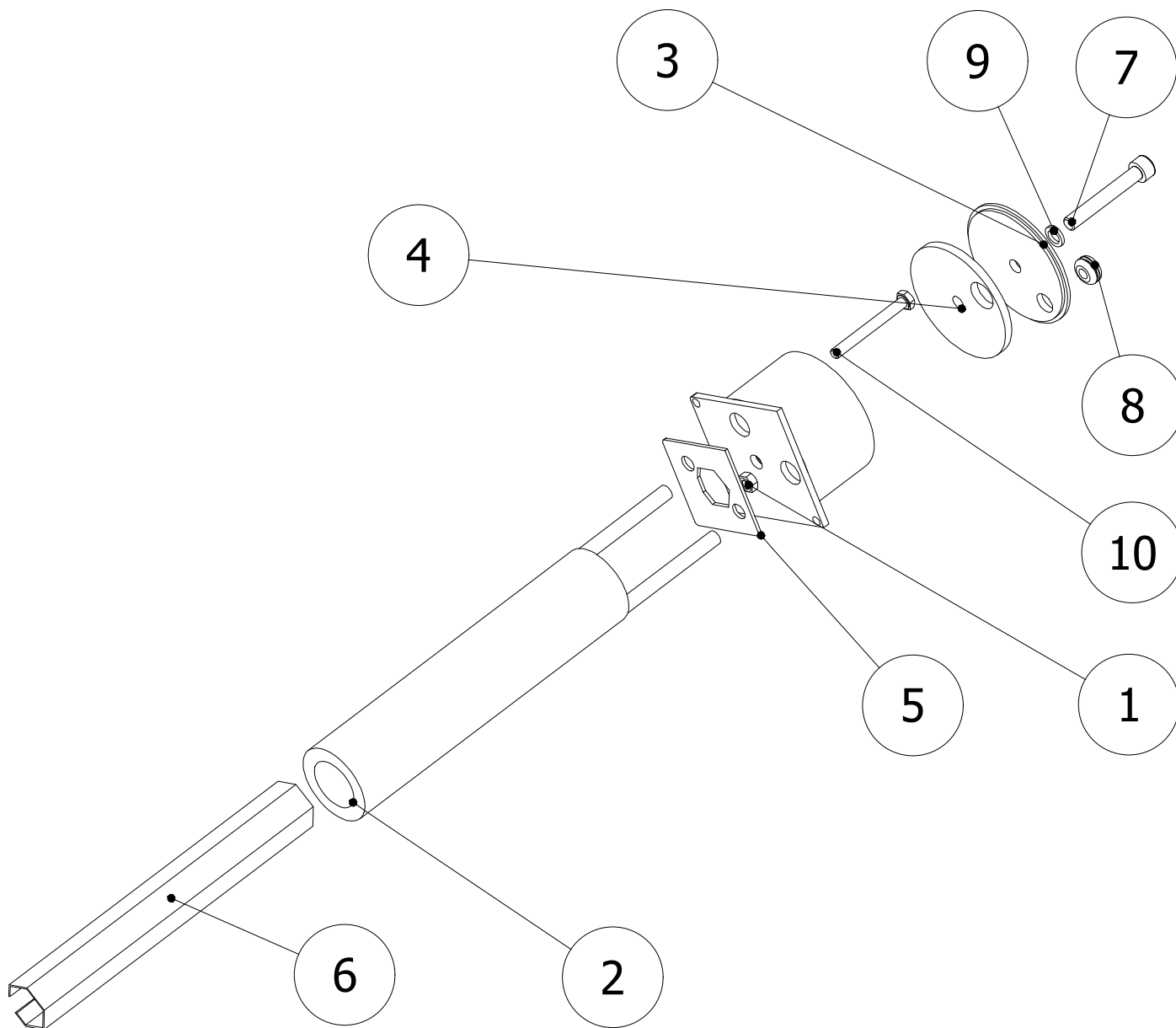
# SYSTÉM ZAPALOVÁNÍ A302,A602

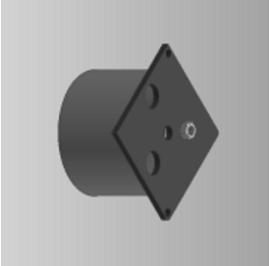
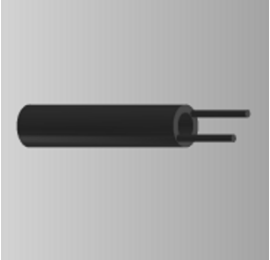

SYSTÉM ZAPALOVÁNÍ A302,A602	POZICE	POPIS	KÓD	ČÍSLO SOUČÁSTI	POČET KS	POZNÁMKY
	1	KRABICE ZAPALOVÁNÍ	PVHXX0148	875.A11.000.A4	1	
	2	Těleso topné 1200W/230V	MERX0671	m22.0222	1	
	3	KRYTKA ZAPALOVÁNÍ	PVHXX0081	886.S11.003.A4	1	
	4	TĚSNĚNÍ ZAPALOVÁNÍ	PVHXX0082	886.S11.004.A4	1	
	5	KRYTKA 2	MVHVH00	875.S11.005.A4	1	
	6	Jádro spirály P 1- 73.5x214	ZVKX0122	b022.49535	1	

SYSTÉM ZAPALOVÁNÍ A302,A602	POZICE	POPIS	KÓD	ČÍSLO SOUČÁSTI	POČET KS	POZNÁMKY
	7	Šroub s válcovou hlavou M8 x 55	MSSX0238	DIN 912	1	
	8	PRŮCHODKA 16x6.4x12.5x1.6x8	MRUZ0403	Obj.č.10605	1	
	9	Pružná podložka - 8	MSPX0006	DIN 7980	1	
	10	Šestihranný šroub - M6 x 55	MSSX0237	ISO 4017	1	

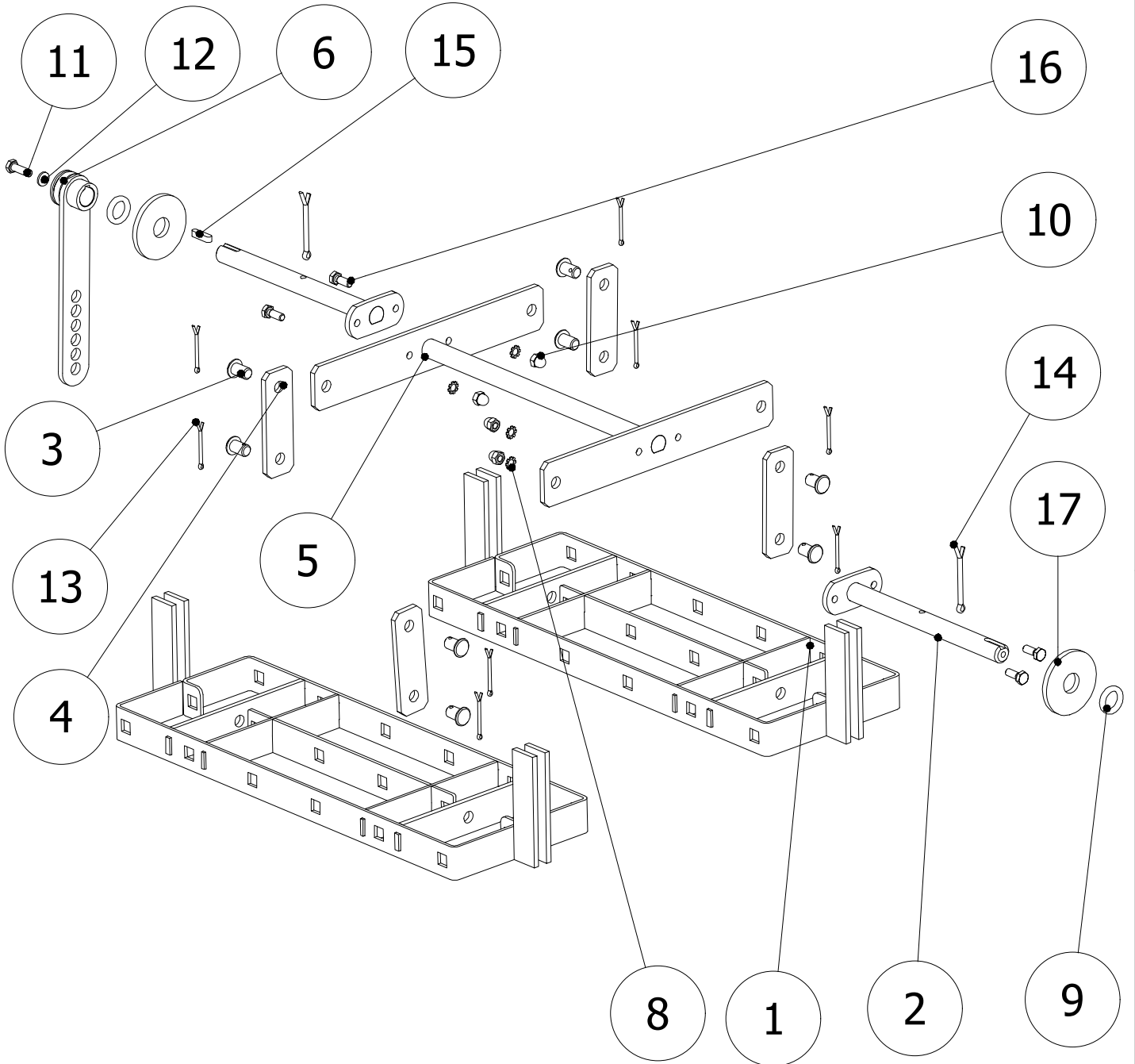

# ČISTĚNÍ VÝMĚNÍKU



ČISTĚNÍ VÝMĚNÍKU	POZICE	POPIS	KÓD	ČÍSLO SOUČÁSTI	POČET KS	POZNÁMKY
	1	VAHADLO	PKTX0391	797.S01.000.A3	2	
	2	NÁSTAVEC	PKTX0389	797.S06.S00.A4	2	
	3	ČEP	PKTX0053	005.S16.007.A4	8	
	4	ZÁVĚS	PKTX0051	005.S16.004.A4	4	
	5	HŘÍDEL SPOJOVACÍ	PKTX0340	761.S06.A00.A3	1	
	6	RAMENO	PKTX0163	445.S08.000.A4	1	

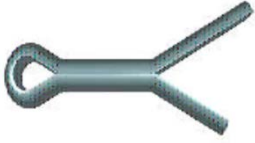
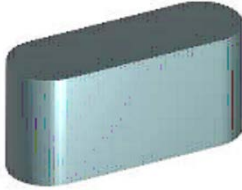
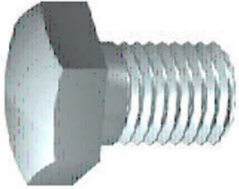

ČISTĚNÍ VÝMĚNÍKU	POZICE	POPIS	KÓD	ČÍSLO SOUČÁSTI	POČET KS	POZNÁMKY
	8	Vějířová pojistná podložka- A 6,4	MSPX0012	DIN 6797	4	
	9	Šňůra těs. čišťení 4x4	PKTX0432		2	
	10	Šestihranná matice uzavřená - M6	MSMX0027	DIN 1587	4	
	11	Šestihranný šroub - M6 x 20	MSSX0006	ISO 4017	1	Zn
	12	Ploché podložky - 6 - 140 HV	MSPX0026	ISO 7089	1	
	13	Závlačka - 2,5 x 36	MSRX0048	ISO 1234	8	

ČISTĚNÍ VÝMĚNÍKU	POZICE	POPIS	KÓD	ČÍSLO SOUČÁSTI	POČET KS	POZNÁMKY
	14	Závlačka - 4 x 50	MSRX0021	ISO 1234	2	
	15	Těsné pero - A 5 x 5 x 22	MSRX0006	DIN 6885	1	
	16	Šestihranný šroub - M6 x 16	MSSX0015	DIN 933	4	
	17	Ploché podložky - ST 16 - 100 HV	MSPX0030	ISO 7094	2	

# MECHANISMUS ČISTĚNÍ

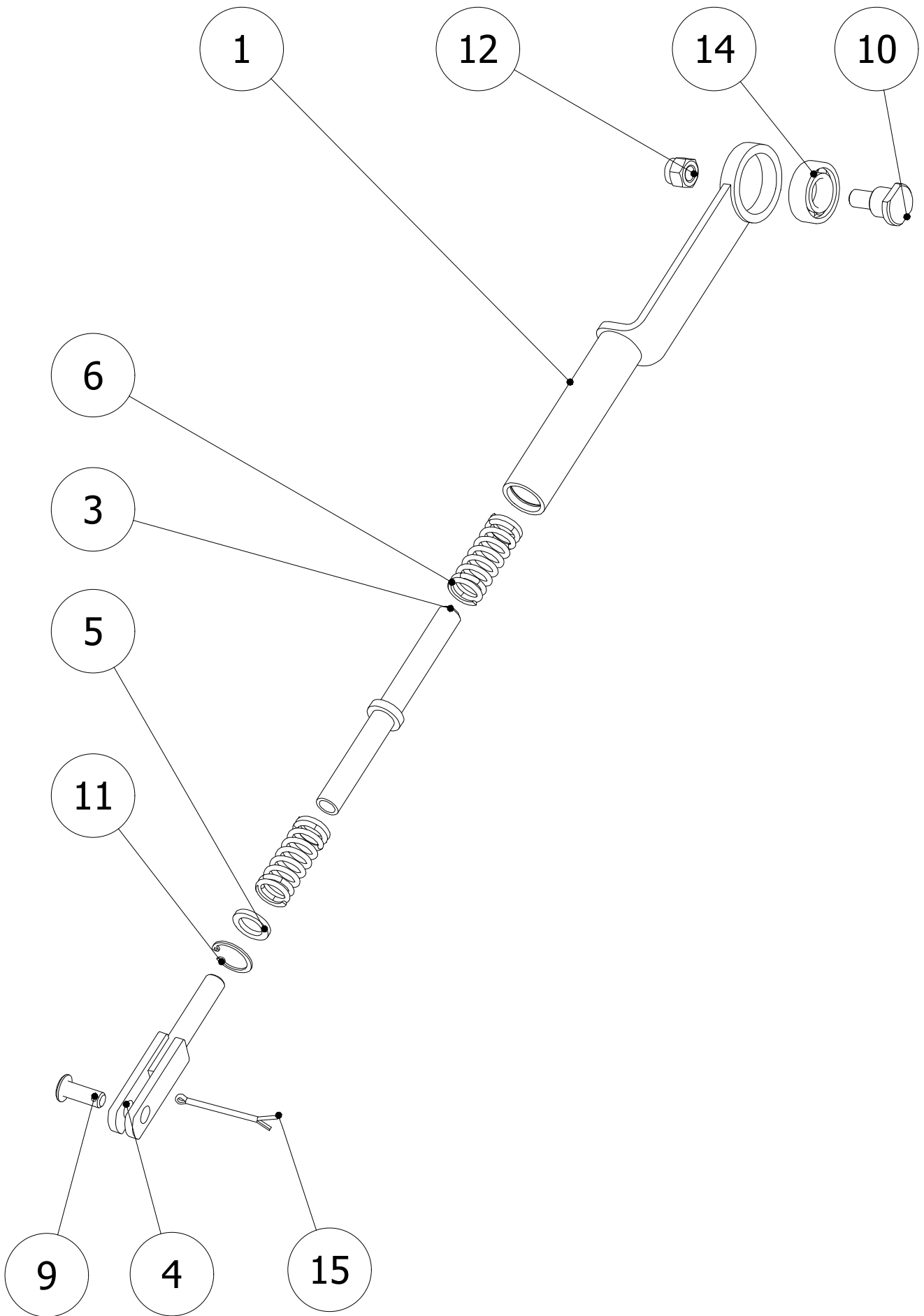

Mechanismus čišťení	POZICE	POPIS	KÓD	ČÍSLO SOUČÁSTI	POČET KS	POZNÁMKY
	1	ÓJE ČISTĚNÍ	PKTX0167	424.S01.000.A4	1	
	3	ČEP VEDENÍ	PKTX0170	424.003.000.A4	1	
	4	VIDLICE	PKTX0171	424.S04.000.A4	1	
	5	VÍČKO	MHVT0139	424.005.000.A4	1	
	6	PRUŽINA TLAČNÁ	MRUZ0065		2	
	9	ČEP 1	PKTX0175	424.009.000.A4	1	

Mechanismus čišění	POZICE	POPIS	KÓD	ČÍSLO SOUČÁSTI	POČET KS	POZNÁMKY
	10	ČEP	PKTX0176	424.010.000.A4	1	
	11	Pojistné kroužky pro díry - 22	MSRX0014	CSN 02 2931	1	
	12	Samojistné šestihřanné matice - M10	MSMX0006	ISO 7041	1	
	14	Kuličková ložiska jednořadá - 6003 2RS	MRUZ0048	CSN 02 4630	1	
	15	Závlačka - 3,2 x 50	MSRX0059	ISO 1234	1	

POHON ČISTĚNÍ

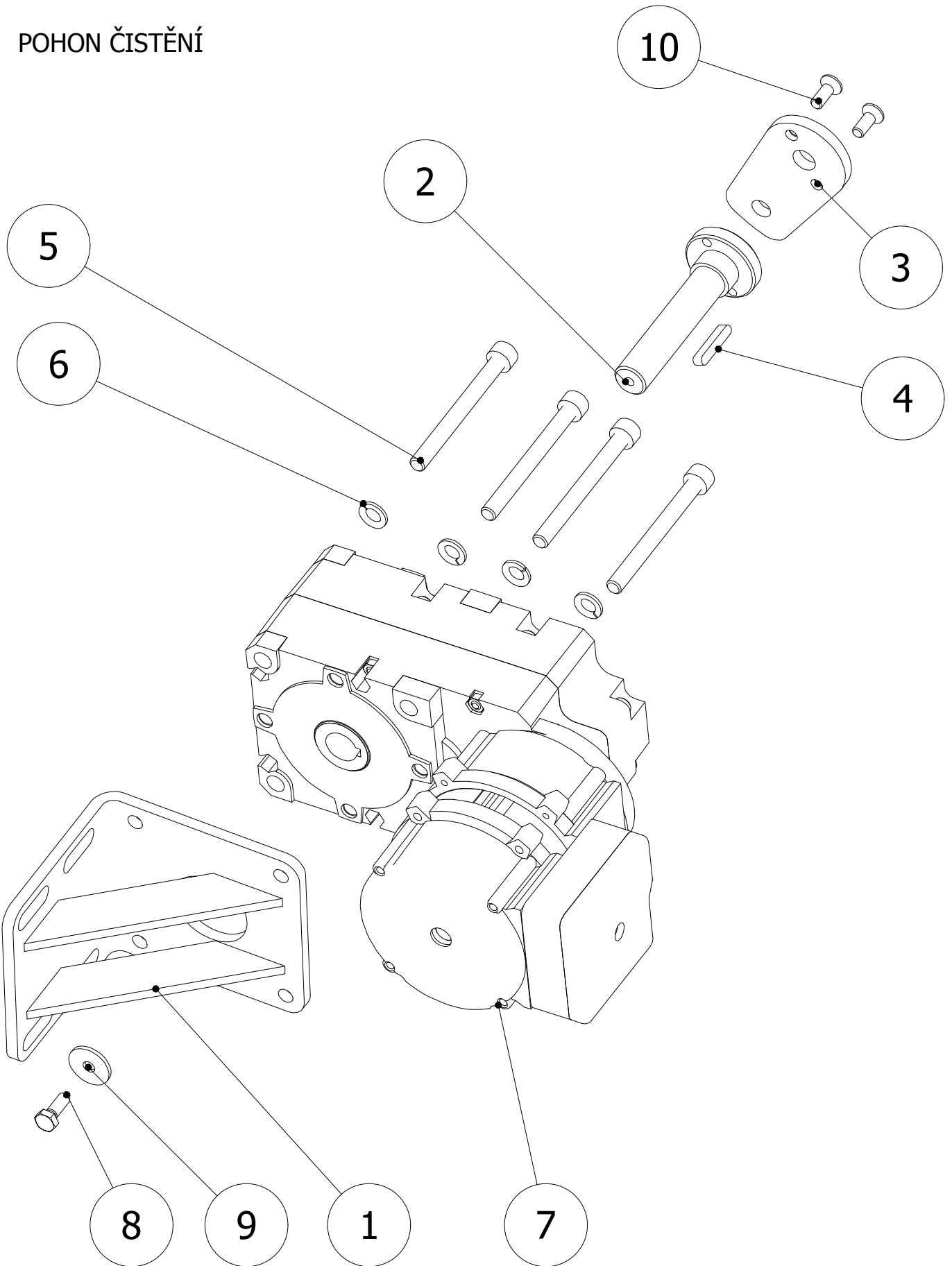

POHON ČISTĚNÍ TAHŮ	POZICE	POPIS	KÓD	ČÍSLO SOUČÁSTI	POČET KS	POZNÁMKY
	1	DRŽÁK MOTORU	PKTX0216	446.S01.000.A3	1	
	2	UNAŠEČ	PKTX0218	446.002.000.A3	1	
	3	PÁKA	PKTX0179	397.S25.003.A4	1	
	4	Těsné pero - A 5 x 5 x 30	MSRX0007	DIN 6885	1	
	5	Šroub s válnovou hlavou - M8 x 80	MSSX0045	DIN 912	4	
	6	Pružná podložka - A8	MSPX0006	DIN 128	4	

POHON ČISTĚNÍ TAHŮ	POZICE	POPIS	KÓD	ČÍSLO SOUČÁSTI	POČET KS	POZNÁMKY
	7	Motor EPO MRB 0,12kW/2p	MEMP0065		1	
	8	Šestihranný šroub - M6 x 16	MSSX0015	DIN 933	1	
	9	Podložka 6	MSPX0002	DIN 440R	1	
	10	Šroub se zápusťnou hlavou - M6 x 16	MSSX0096	DIN 7991	2	
	11	Kabel SIHF 3G 1	MEKV0003		1.5m	



# POHON VYMETÁNÍ

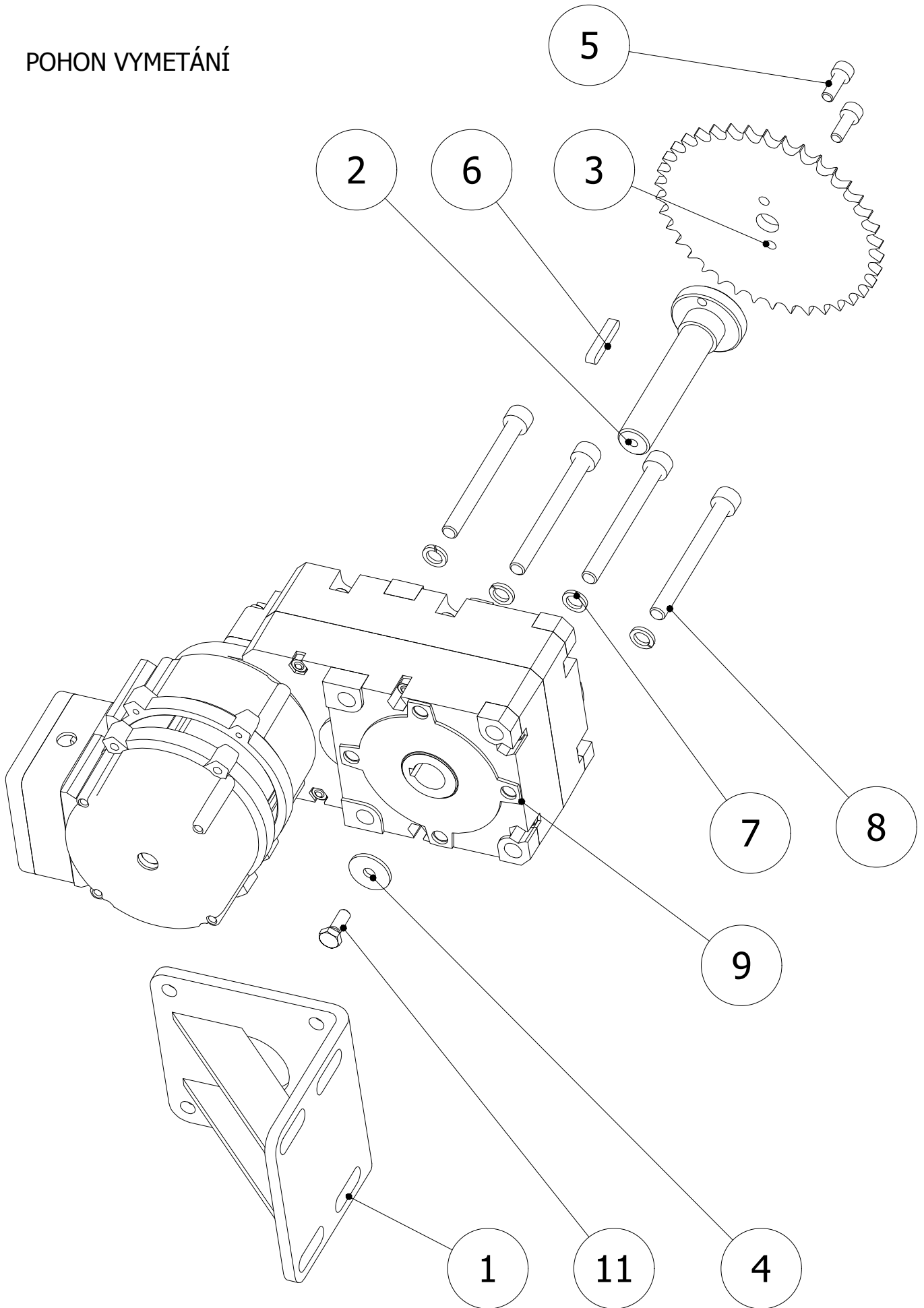

POHON VYMETÁNÍ POPELA KP62	POZICE	POPIS	KÓD	ČÍSLO SOUČÁSTI	POČET KS	POZNÁMKY
	1	DRŽÁK MOTORU	PKTX0216	446.S01.000.A3	1	
	2	UNAŠEČ	PKTX0218	446.002.000.A3	1	
	3	KOLO ŘETĚZOVÉ ÚPRAVA	PKTX0225	446.003.000.A4	1	
	4	Podložka 6	MSPX0011	DIN 440R	1	
	5	Šroub s válcovou hlavou - M6 x 16	MSSX0098	ISO 4762	3	
	6	Těsné pero - A 5 x 5 x 30	MSRX0007	DIN 6885	1	

POHON VYMETÁNÍ POPELA KP62	POZICE	POPIS	KÓD	ČÍSLO SOUČÁSTI	POČET KS	POZNÁMKY
	7	Pružná podložka - 8	MSPX0006	DIN 7980	4	
	8	Šroub s válcovou hlavou - M8 x 80	MSSX0045	DIN 912	4	
	9	Motor EPO MRB 0,06kW/4p	MEMP0040		1	
	10	Šestihranný šroub - M6 x 16	MSSX0015	DIN 933	1	
	11	ŘETĚZ 06 B-1, 113 ČLÁNKŮ (3.8x7.32)	MRUZ0142		1	
	12	ČLÁNEK SPOJOVACÍ JEDNOŘ.	MRUZ0041		1	
	13	KABEL SIHF 3G 1	MEKV0003		1,2m	

KÓD	POPIS	MNOŽSTVÍ
MEKV0003	Kabel SIHF 3G 1	3,44m
MEKV0006	Kabel H07 V-K 2.5 zž.	0,176m
MEKV0007	Kabel SIHF 3x1.5	1m
MEKV0011	Kabel H03VV-F 2x0,5	1m
MEKV0027	Kabel H05VV-F 3G 1,5	1m
MEKV0037	Kabel H07V-K 1,5 zž	3m
MEKV0047	Šňůra FLEX H05VV-F 3x1,5 5m	1ks
MEKV0054	Kabel CSSS 2Dx1/VO5SS-F/ silikon	1m
MEKV0065	Kabel LiYY 4x0,14	5m
MEKV0070	Kabel H05VV-F 4G1,5B	4,5m
MEKV0071	Kabel H07V-K 1,5 sv.modr	2,5m
MEKV0072	Kabel H07V-K 1,5 černý	3m
MERX0003	Objímka plochá BF-F 608P	8ks
MERX0004	Dutinka lis. DI 1.0-10 10	37ks
MERX0016	Svorka WAGO 222-413	4ks
MERX0020	Canon 9 V (RKP 12157)	1ks
MERX0027	Trubička smršť. 3,2/1,6 SB/PBF-1/8	0,05m
MERX0030	Objímka plochá RF-F 608P	3ks
MERX0043	Canon sada matic CTB	1ks
MERX0051	Vývodka PG 9 s matkou	16ks
MERX0067	Přichytka PKB-BS 27x27mm přírodní samolepící	3ks
MERX0073	Svorka WAGO 222-415	1ks
MERX0078	Štítek uzemění malý /baleno po 40 ks/	4ks
MERX0126	Oko lisovací RF-M4	6ks
MERX0151	Spirála svazkový SPC10	1m
MERX0158	Pásek vázací 200/3,6	8ks
MERX0205	Vývodka PG 7	9ks
MERX0221	Kolík ploch.přístroj. SEZC7202-00/4/100	4ks
MERX0237	Konektor RJ 45-8/8 C5 dr vidlice	1ks
MERX0282	Konektor RJ 45-8 Cat.5e UTP	1ks
MERX0529	Kolík dvojitý 7242-00/5/4	1ks
MERX0581	Filtr odrušovací MIFLEX FP-250/16	1ks
MERX0621	Matka Pg 7 sv. šedá	9ks
MERX0631	Konektor 2,5 / 3 green SIGMATEK	16ks
MERX0632	Konektor 1,5 / 2 green SIGMATEK	15ks
MERX0633	Konektor 2,5 / 2 green SIGMATEK	1ks

KÓD	POPIS	MNOŽSTVÍ
MERX0634	Konektor 2,5 / 4 green SIGMATEK	4ks
MERX0635	Konektor 1,5 / 4 green SIGMATEK	1ks
MERX0636	Konektor 1,5 / 3 green SIGMATEK	1ks
MERX0641	Kryt P - Canon 9	1ks
MERX0648	Spirála svazkovací SPC15	0,5m
MERX0661	Buž. smrš. SB 3,2/1,6 Mo modrá	0,06m
MERX0662	Zástrčka ST18 -3 pol.č. Wieland	1ks
METRO071	Deska základní HZS 521-G	1ks
METRO072	Modul expandér HZS 532-1	1ks
METRO083	Snímač teploty příložený KS 154A KTY 81-110, 3,5m	2ks
METRO085	Snímač teploty TG8-55 KTY 81-110, 1,5m voda	1ks
METRO087	Snímač teploty pro ven. KS 114B, KTY 81-110	1ks
METRO108	Snímač teploty TR 050J-x TCK,silicon zelený 1,4m	1ks
METRO197	Zásuvka kabel. NAC42S.B černá ENSTO	1ks
MREZ0012	Etiketa stříbrná 210x297	1ks
MRUZ0211	FlashDisk USB 2,0 Sandisk Cruzer Fit 8GB	1ks
MRUZ0219	Průchodka 24,9 x 1,6 Moss 11214	1ks
MRUZ0220	Podložka tlum. 10x10x2,5 čtvercová 35604-0	5ks
MRUZ0272	Zátka antivibrační 1/2 BSP - velikost 8	1ks
MRUZ0274	Zátka souběžná 46.1MM č.465668	3ks
MRUZ0275	Fólie laminovací A4	1ks
MRUZ0356	samolepka logo VERNER pryskyř. m50.0345	1ks
MRUZ0466	Samolepka A 602 černá	1ks
MTBX0033	Páska oboustranně lepící š.=15mm	0,02ks





**PONAST spol. s r.o**  
Na Potůčkách 163  
757 01 Valašské Meziříčí

**ČESKÁ REPUBLIKA**

[www.ponast.cz](http://www.ponast.cz)

e-mail: [servis@ponast.cz](mailto:servis@ponast.cz)

**VERNER SK s.r.o**  
Klincová 37/b  
821 08 Bratislava

**SLOVENSKÁ REPUBLIKA**

e-mail: [kotle-verner@email.cz](mailto:kotle-verner@email.cz)